

# 第十七届全国大学生结构设计竞赛分区赛（安徽） 暨第七届安徽省大学生结构设计竞赛（1号通知） 邀请函

尊敬的高等院校领导、老师：

您好！为激发安徽省内高校大学生的创新意识，培养大学生的工程创新、团队协作和实践能力，加强高校学生之间的交流与合作，并推进高校实践教育教学改革，提高人才培养质量。经安徽省教育厅研究，决定举办第十七届全国大学生结构设计竞赛分区赛（安徽）暨第七届安徽省大学生结构设计竞赛。根据安徽省大学生结构设计竞赛组织委员会的安排，本次竞赛由安徽工程大学建筑工程学院具体承办。

本次竞赛拟定于2024年6月20-23日（暂定；如有变更，另行通知）在安徽工程大学（校本部）举行。

竞赛指定邮箱：[jjg@jstcamp.com](mailto:jjg@jstcamp.com)

第七届大学生结构设计竞赛组织委员会秘书处联系方式：





7

1.

3

423:      ã    ö  
             4243



2.

4

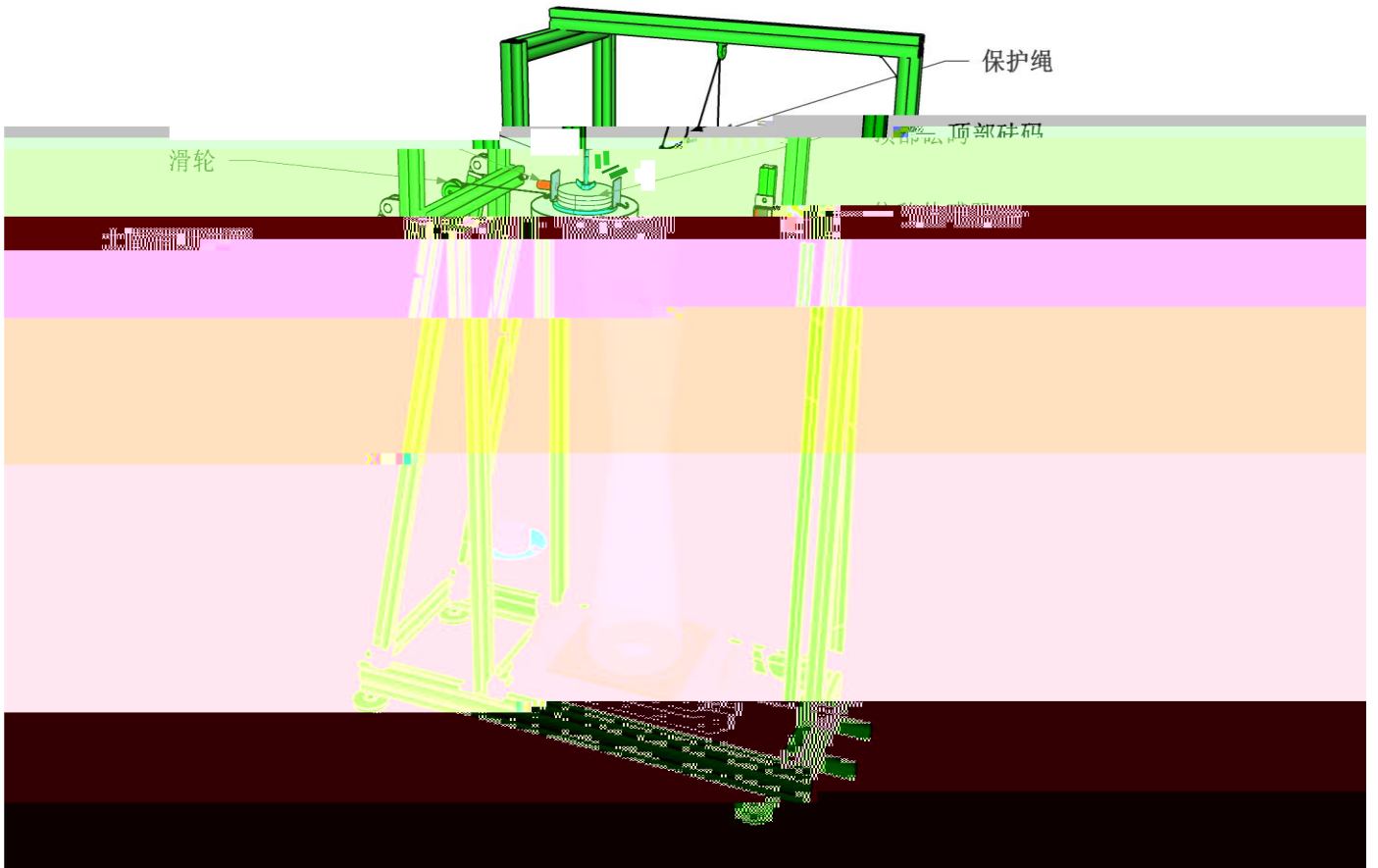

4"

5

3

4

5220 o

3220 o

4220 o

0700

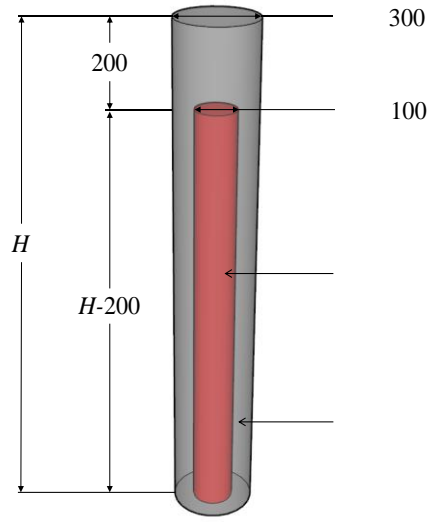

5"

00

6 3700

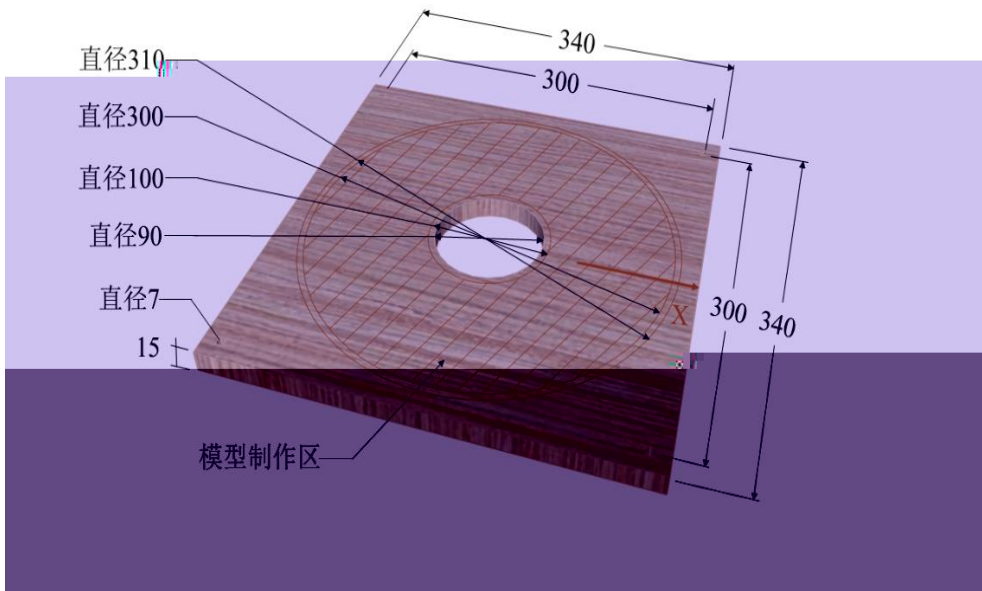

6"

00

3.

2

4

4

422

1

7

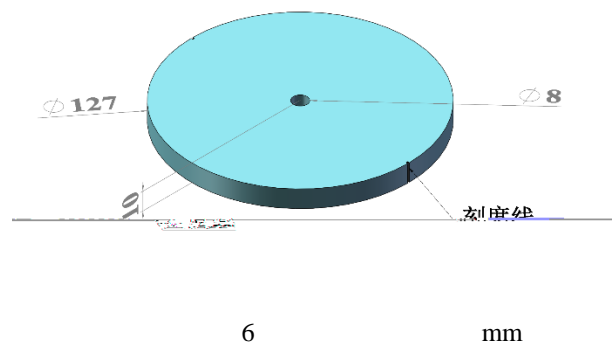
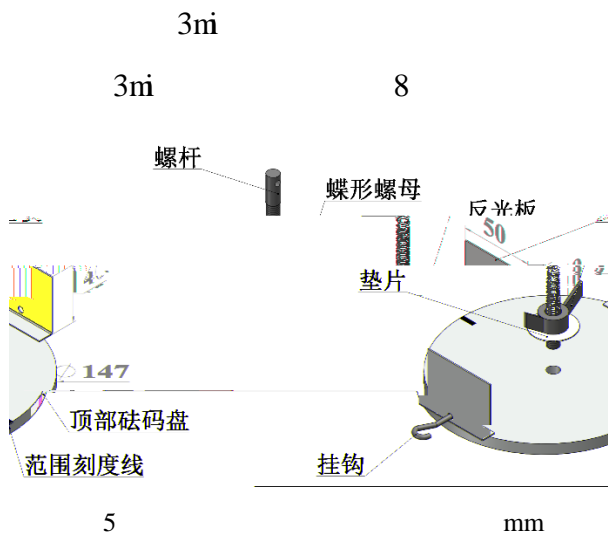

9

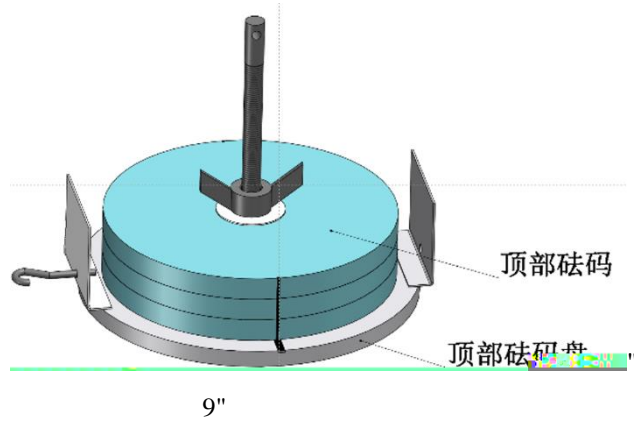

2

: 06 06 3200  
3 472

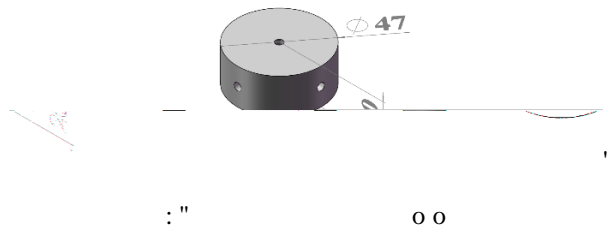

3

4 9  
- 5200 62200

4

4

4.

34

5.

3

4

3

4

3"

$m_1$	4kg
$m_2$	5kg
$u_0$	25mm
$f_1$	3Hz
$H$	1000mm
$f_3$	4Hz

4"

1	X
2	0 ±1kg ±2kg

6.

3

3



(2)

5

6

(3)

724 52i " 8

(4)

4 "C5" "5o o "

(5)

3

3

$m_A$

208

3

5

mm			
	1250×430×0.20 (+0.05)		1
	1250×430×0.35 (+0.05)		1
	1250×430×0.50 (+0.05)		1
	930×6×1.0 (+0.5)		20
	930×2×2.0 (+0.5)		20
	930×3×3.0 (+0.5)		20

7

4

5

7

4

4

9.

$$m_C (m_C^2 - m_A^2),$$

ck

"208

10.

$$M_{0i}^? \quad ck \quad m_C^-$$

3

3

320 o

42u

4

4

32u

Ö 2

5

5

420 o

42u

7

## 12.

- (1) " 5
- (2) " "90 6
- (3) " "90 9
- (4) " 404
- (5) " 3308

(1)

(2)

(3)

(4)

(5)

(1)

7

(2)

32

(3)

7

(4)

:2

**1**

$$u_i \quad 0 \quad 0$$

$$s_i = u_0 - u_i,$$

$$D_{2i} = \begin{cases} 40k_{2i}, & 0 < s_i \leq 5 \\ (60 - 4s_i)k_{2i}, & 5 < s_i < 15 \\ 0, & s_i \geq 15 \end{cases}$$

3)

42

$5k^2 m_{3i} / M_{0i}$

2k

$m_{3i}$

5k

5.0 cz

$5k^2 42k_{3i} / k_{3,\max}$

4)

k

$k^2 \quad 3k \quad 4k \quad 5k$

(5)

k

k

"2"

3

:

3

3

3

3

32

4

3308

3

3

3

3

32

5

3308

7

7

3

4

3

3

2

i

$$S_i = A_i + B_i + C_i + D_i \quad F_i$$

13.

RMRO

3: 723473278

ö

ö

RMRO

SS 7; 5482332



3: 8; 3; 77849

4246

SS 6; 6492: 35

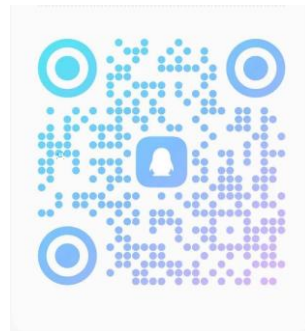
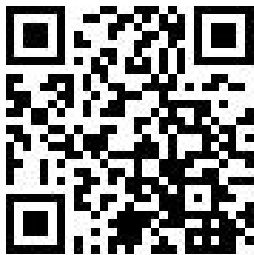

35; : 8342942

1

DCODQQ

532

"""" 1 352: 4: 28576

2 2

724

J U52 52i

j w u l k g o 0 c q d c q 0 q o l k g o 0 j w A n ? ( k ? 776; 72894; 44

"""" 1 3597732: 528"""" S S 639; : : 2

3

3





4

7""

1	A3 3.0	2	
2	6mm	1	
3	140mm	1	
4	33cm	1	
5	1m 50cm	1	
6	320 800 1500	1	
7	5	1	
8		1	
9		3	
10		1	
11		1	
12			
13			
14			

6

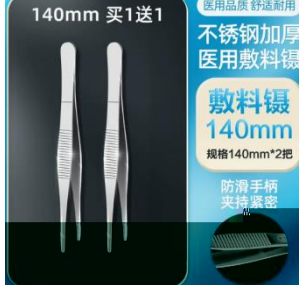
--	--	--	--	--

1	A3 3.0	19	<a href="https://item.taobao.com/item.htm?spm=a1z09.2.0.0.4e2a2e8do67KB6&amp;id=531970388373&amp;_u=b1r43k6lb929">https://item.taobao.com/item.htm?spm=a1z09.2.0.0.4e2a2e8do67KB6&amp;id=531970388373&amp;_u=b1r43k6lb929</a>	
2	6mm	7	<a href="https://detail.tmall.com/item.htm?abbucket=19&amp;id=17896274584&amp;ns=1&amp;skuId=5030786303445&amp;spm=a230r.1.14.25.79ae1550wGZjaG">https://detail.tmall.com/item.htm?abbucket=19&amp;id=17896274584&amp;ns=1&amp;skuId=5030786303445&amp;spm=a230r.1.14.25.79ae1550wGZjaG</a>	
3	140mm	12.5	<a href="https://detail.tmall.com/item.htm?abbucket=12&amp;id=679108892988&amp;ns=1&amp;spm=a230r.1.14.25.4d5636b59ZbulM&amp;skuId=4876077345893">https://detail.tmall.com/item.htm?abbucket=12&amp;id=679108892988&amp;ns=1&amp;spm=a230r.1.14.25.4d5636b59ZbulM&amp;skuId=4876077345893</a>	
4	33cm	15.5	<a href="https://detail.tmall.com/item.htm?id=38879201788&amp;spm=a1z09.2.0.0.618f2e8datT17x&amp;_u=c1r43k6lcd6b&amp;skuId=85683895981">https://detail.tmall.com/item.htm?id=38879201788&amp;spm=a1z09.2.0.0.618f2e8datT17x&amp;_u=c1r43k6lcd6b&amp;skuId=85683895981</a>	
5	1m	32.5	<a href="https://detail.tmall.com/item.htm?id=587408384991&amp;spm=a1z09.2.0.0.618f2e8datT17x&amp;_u=c1r43k6lbd87&amp;skuId=4421675443314">https://detail.tmall.com/item.htm?id=587408384991&amp;spm=a1z09.2.0.0.618f2e8datT17x&amp;_u=c1r43k6lbd87&amp;skuId=4421675443314</a>	



	0.5m	12.9	<a href="https://detail.tmall.com/item.htm?_u=hkkor6m2ad4&amp;id=544612451851&amp;spm=a1z09.2.0.0.2a5c2e8dxRktjD&amp;skuId=4792761205956">https://detail.tmall.com/item.htm?_u=hkkor6m2ad4&amp;id=544612451851&amp;spm=a1z09.2.0.0.2a5c2e8dxRktjD&amp;skuId=4792761205956</a>	
6	320	19 10	<a href="https://detail.tmall.com/item.htm?id=576380649122&amp;spm=a1z09.2.0.0.618f2e8datT17x&amp;_u=c1r43k6l6433&amp;skuId=3961351130993">https://detail.tmall.com/item.htm?id=576380649122&amp;spm=a1z09.2.0.0.618f2e8datT17x&amp;_u=c1r43k6l6433&amp;skuId=3961351130993</a>	
	800	20 10		

10	6	8.5	<a href="https://detail.tmall.com/item.htm?_u=hkkor6m3091&amp;id=590144429353&amp;spm=a1z09.2.0.0.635d2e8dGjQdt9&amp;skuId=4212918107950">https://detail.tmall.com/item.htm?_u=hkkor6m3091&amp;id=590144429353&amp;spm=a1z09.2.0.0.635d2e8dGjQdt9&amp;skuId=4212918107950</a>	 <p>平板锉 6寸</p>																
11	3	5.5	<a href="https://detail.tmall.com/item.htm?abbucket=19&amp;id=692899480676&amp;ns=1&amp;skuId=4937833665806&amp;spm=a230r.1.14.7.2c6b3812dnRDF7">https://detail.tmall.com/item.htm?abbucket=19&amp;id=692899480676&amp;ns=1&amp;skuId=4937833665806&amp;spm=a230r.1.14.7.2c6b3812dnRDF7</a>	 <p>ABS耐摔款钢卷尺 3M*19</p> <p>加厚加宽防刺手</p> <table border="1"> <thead> <tr> <th>规格</th> <th>长*宽*高</th> <th>尺带宽度</th> <th>水平精度</th> <th>垂直精度</th> </tr> </thead> <tbody> <tr> <td>3M*19</td> <td>65*30*60MM</td> <td>19MM</td> <td>1.6M</td> <td>2.2M</td> </tr> </tbody> </table>	规格	长*宽*高	尺带宽度	水平精度	垂直精度	3M*19	65*30*60MM	19MM	1.6M	2.2M						
规格	长*宽*高	尺带宽度	水平精度	垂直精度																
3M*19	65*30*60MM	19MM	1.6M	2.2M																
12	<table border="1"> <tr> <td>M4*10</td> <td>4.94 100</td> </tr> <tr> <td>M4*12</td> <td>5.42 100</td> </tr> <tr> <td>M4*16</td> <td>6.40 100</td> </tr> <tr> <td>M4*25</td> <td>2.41 50</td> </tr> </table>	M4*10	4.94 100	M4*12	5.42 100	M4*16	6.40 100	M4*25	2.41 50	<table border="1"> <tr> <td>M4*10</td> <td>4.94 100</td> </tr> <tr> <td>M4*12</td> <td>5.42 100</td> </tr> <tr> <td>M4*16</td> <td>6.40 100</td> </tr> <tr> <td>M4*25</td> <td>2.41 50</td> </tr> </table>	M4*10	4.94 100	M4*12	5.42 100	M4*16	6.40 100	M4*25	2.41 50	<a href="https://m.tb.cn/h.5pbkUUS?tk=ZiOrW6rFwcx">https://m.tb.cn/h.5pbkUUS?tk=ZiOrW6rFwcx</a>	 <p>百端特</p>
M4*10	4.94 100																			
M4*12	5.42 100																			
M4*16	6.40 100																			
M4*25	2.41 50																			
M4*10	4.94 100																			
M4*12	5.42 100																			
M4*16	6.40 100																			
M4*25	2.41 50																			
13	(5-25N.m+510mm)	88	<a href="https://mobile.yangkeduo.com/goods.html?refer_share_id=pqf898kNbSYPGWllu0u5m1xWTHrOZwu6&amp;refer_share_channel=copy_link&amp;_oak_share_detail_id=3934378434&amp;_x_share_id=0sB8IhRVdfIBe2vFgO68N99emSDPVp79&amp;_oc_trace_mark=199&amp;_oak_share_time=1704385521&amp;pxq_secret_key=ZEUXN00IHV5YY3BIKPNAWVXQT2NO62USJ4N6EMJLKXGGICCKQ66Q&amp;wvx=10&amp;share_uin=6NOD3D2ZALU6JPNDRF7HXZ3F3I_GEXDA&amp;_x_query=">https://mobile.yangkeduo.com/goods.html?refer_share_id=pqf898kNbSYPGWllu0u5m1xWTHrOZwu6&amp;refer_share_channel=copy_link&amp;_oak_share_detail_id=3934378434&amp;_x_share_id=0sB8IhRVdfIBe2vFgO68N99emSDPVp79&amp;_oc_trace_mark=199&amp;_oak_share_time=1704385521&amp;pxq_secret_key=ZEUXN00IHV5YY3BIKPNAWVXQT2NO62USJ4N6EMJLKXGGICCKQ66Q&amp;wvx=10&amp;share_uin=6NOD3D2ZALU6JPNDRF7HXZ3F3I_GEXDA&amp;_x_query=</a>																	

			<p>%E8%AE%B8%E4%B8%89%E5%A4%9A&amp;page_from=39&amp;refer_share_uin=6NOD3D2ZALU6JPNDRF7HXZ3F3I_GEXDA&amp;_wv=41729&amp;goods_id=560345454082&amp;_oak_share_snapshot_number=4680&amp;_x_org=2</p>	
14	<p>100w +60 +</p>	69.9	<p><a href="https://m.tb.cn/h.5og8EXs?tk=tJxRW6gTICc">https://m.tb.cn/h.5og8EXs?tk=tJxRW6gTICc</a></p>	

1				
2				
Email				

3

4

2024 3 22

jgsjjs7ahpu@126.com

13721219728

13955365686

15005530684

